

Installation Guide



SolarStrap™ Installation Manual
Copyright© 2023 by SolarStrap™. All rights reserved.

www.solarstrap.com

The SolarStrap™ is made in the U.S.A. with quality assurance. The unique features of this product and design are patented and copying of intellectual property without its written consent is prohibited and subject to strict enforcement.

The information contained herein is subject to change without notice.

Designed, and Manufactured by:

SolarStrap™
A CATALYZE COMPANY

10305 Birtcher Dr,
Jurupa Valley, CA 91752
323-953-2969
www.SolarStrap.com



Rowan Williams Davies & Irwin Inc.
Wind Tunnel Tested per ASCE Standard 7 and ASCE 49
Report Number 1803163



International Code Council Evaluation Services
ICCESR-3839 SolarStrap™ Attachment System
www.icc-es.org



CERTIFIED
Solar PTL
www.solarptl.com

UL1703 20150519 §48.1.b)1): The system achieves a Class A fire rating when installed in the manner specified in these instructions.
UL2703 First Edition 20150128 §26.1: The system has achieved a Class A fire rating when installed with Type 1, Type 2 and Type 3 modules.
UL 2703 Certificate No. TU 722190005.01



City of Los Angeles Research Report
LA RR 26108
www.ladbs.org



ul.com
File No. E356152
UL467 Report: QIMS2.E356152
UL467 Intertek Report: 101005952LAX-001
UL1703: Class A Pending or currently exempt as a roof mount only system (subject to module fire class rating)
UL2703 Certificate of Compliance: 20140820 – E356152



www.akstamping.com



CAUTION

Installer must read this manual before attempting installation. Failure to correctly establish the requirements of the proposed installation site is dangerous and can void the framing or roofing warranty. Please contact Casey Smith at 323-953-2969 or at casey@solarstrap.com to verify latest revision of this manual

Table of Contents

Before You Start	
Handling & Installing.....	4
Roof Loading Resistance, and Seismic Attachments.....	4
Features.....	4
System Overview	
Diagram.....	5
Components.....	5
Preparing to Build	
Required Tools and Safety Equipment	6
Planning and Layout	
Setting Up the Roof.....	7
Roof Layout.....	8
Laydown Straps	8
Installation	
Add Brackets	9
Place Modules	10
Clamp Installation.....	11
Wire Management and Grounding	12
Grounding the Array Example	13
Seismic Engineering	
Application of Seismic Building Codes.....	14
Roof Connection	
Attachment Details for Built-up or Asphalt Roofs	15
Attachment Details for TPO or PVC Roofs	16
Attachment Detail for Premium TPO or PVC Roofs.....	17
Notes	
Parts List.....	18
Certifications and Approved Modules	
PTL UL2703 - Conformance	19
PTL UL2703 - Approved Modules	19
Warranty	
SolarStrap™ Limited Warranty Statement.....	20
Revision History	
Log of changes to install manual.....	21
Warranty Check List	
Warranty check list	22

BEFORE YOU START

Handling & Installing

It is critically important to observe standard safety practices when installing SolarStrap™:

- Follow all OSHA safety guidelines for construction safety.
- Stop work during stormy weather. Solar modules, SolarStrap, and other components can be blown off the roof in high winds.
- Always secure solar modules, SolarStrap, and other components from unexpected high winds while under construction. Windblown construction materials are a safety hazard.
- Never step or sit on the glass surface of a solar module. The glass may break, resulting in shock or bodily injury.
- Do not throw or roughly handle any SolarStrap™ components.
- Do not bring SolarStrap™ into contact with sharp or heavy objects.
- Do not modify SolarStrap™ components in any way. The exchange of bolts, drilling of holes, bending and any other physical changes not intended in standard installation procedure will void the warranty.
- Products should be installed and maintained by qualified personnel. Keep unauthorized personnel away from solar modules.
- It is the installer's responsibility to verify the integrity of the structure to which SolarStrap™ is used. Roofs or structures with rotten/rusted bearers, undersized bearers, excessively spaced bearers or any other unsuitable substructure cannot be used with SolarStrap™. Installation on such structures could result in death or serious injury.
- Installation is to be periodically re-inspected for loose components, loose fasteners and any corrosion. Any affected components are to be immediately replaced.

Roof Loading Resistance, and Seismic Attachments

Roof loading calculation are based on code approved stress equations and allowable margins of safety. Roof loading calculations must be conservatively performed under wind loads, snow, and dead loads. Components have had full envelope forces applied to each component from engineered data sets approved by the Engineer of Record (EOR). The EOR will review SolarStrap™ wind data tables and choose the appropriate wind uplift values by boundary roof zones. The EOR will choose and compute the quantity and method of positive seismic attachments required based on roof type, roof substructure and seismic locations. This data is either provided as part of the project engineering or from a SolarStrap code compliant dataset.

Features

- Aluminum 5052 - 6061
- Suitable for most buildings
- Suitable for roof slope range $0^{\circ} < 9.5^{\circ}$
- Panel array weight under (3) PSF
- High strength-to-weight ratio
- Spacing efficiency with integrated setback adjustments
- High corrosion resistant materials resulting in low lifetime maintenance and an extended product life
- Complies with ASCE 7-05, 7-10, and 7-16 guidance for design criteria
- Complies with SEAOC PV-1 for seismic designs
- Complies with SEAOC PV-2 guidance for wind tunnel tested arrays
- Wind tunnel tested by RWDI
- Peer reviewed by CPP

SYSTEM OVERVIEW

Diagram

The SolarStrap™ is fast and easy to install with minor field measurements required. The PanStrap option is available when used in conjunction with SolarStraps's wind tunnel test data in compliance with SEAOC PV-2 Guidelines.

Note: The SSS54 or SSOP3 will need to be in every installation for that installation to retain Fire Rating. (UL2703 First Edition 20150128 §26.1)
 Note: Marking plate will be stamped into each SSOP3 near the middle of the part, see location shown below under components.



Components

SolarStrap™ One Piece
w/UL Marking Stamp
SSOP3



SolarStrap™ Low Bracket
(0°, 5°, 10°, 15°) SSLB



SolarStrap™ High
Bracket (5°, 10°, 15°)
SSHB



SolarStrap Pan Strap

SSPS3



SolarStrap™ Bonding Bar
SSBB



Conductive Mid
Clamp*
A3004



Conductive
End Clamp*
A3003



Grounding Lug*
SGB-4



Grounding Lug*
SGB-5



Serrated Hex Flange Nut
SSHWSFN



Conductive Mid Cap*
500100



Conductive End Cap
Universal*
500101



Full Threaded Hex Bolt
SSHWHB



Lock Washer
SSHWLW



SolarStrap™ Attachment
Plate SSAP



SolarStrap™ Inverter Mount
SSIMR**



SolarStrap™ Single Ply
Continuous Cap
10" x 100'
SSCC



SolarStrap™ Single Ply
Cap
11.5" CIRCLE
SSPC



SolarStrap™ Single Ply
Tie
SSPTD

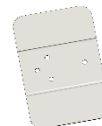

* Note: For certain jurisdictions these items may be single use only. Please check with local AHJ for more information regarding single use bonding
 **Not evaluated under UL listing

PREPARING TO BUILD

Required Tools and Safety Equipment

Chalk Line Reel



7/16" Socket



Measuring Tape



Torque Wrench



Footwear



Gloves



Hard Hat



Safety Glasses



Safety Harness



Safety Vest



PLANNING AND LAYOUT

Setting Up the Roof

Utilizing a grid style pattern, layout arrays on the roof

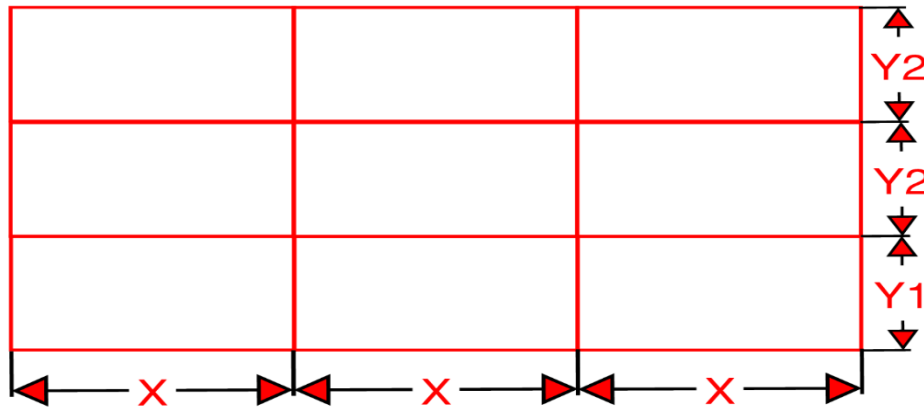

- $X = \text{Module length} + 3/4" (.75")$
 - Center to Center of straps
 - For frameless modules please refer to plan set
- $Y^1 = \text{Varies depending on tilt angle}$
 - From front attachment to second attachment
 - 5° tilt = 38.75"
 - 10° tilt = 43.5"
 - 15° tilt = 45.5"
- $Y^2 = \text{Varies depending on project see plan set for exact measurements}$
 - From second attachment repeating till end of array
- Modules are mounted in Landscape orientation
- Snap and Detail horizontal and vertical lines to identify locations of all attachments

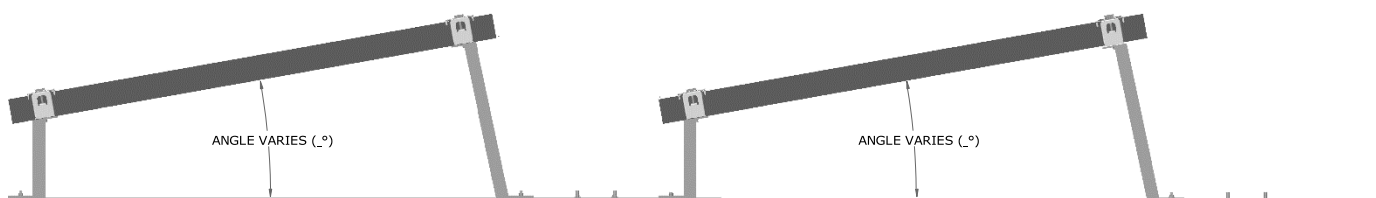

CAUTION

- AHJ may request seismic attachment for certain zones. Verify with your local department of building and safety.
- Be careful to follow final design layout.
- Installer must verify that PV Module manufacturer's attachment points for clamps are met to avoid damage, injuries and module warranty being voided.
- Installers must verify that all building requirements specific to installation site are met, including city, fire department, and other jurisdictions responsible for Residential/Commercial roof inspections.
- Installer must follow all OSHA CFR1926 rules and regulations regarding Job-site safety, fall protection and PPE. For more info visit: www.osha.gov

PLANNING AND LAYOUT

Roof Layout

Utilizing approved plan set locate and install proper attachments on chalk grid pattern.

NOTE: Before making any penetrations into roof, verify warranty information! If you have any question on warranty, contact SolarStrap at info@solarstrap.com or (323) 953-2969

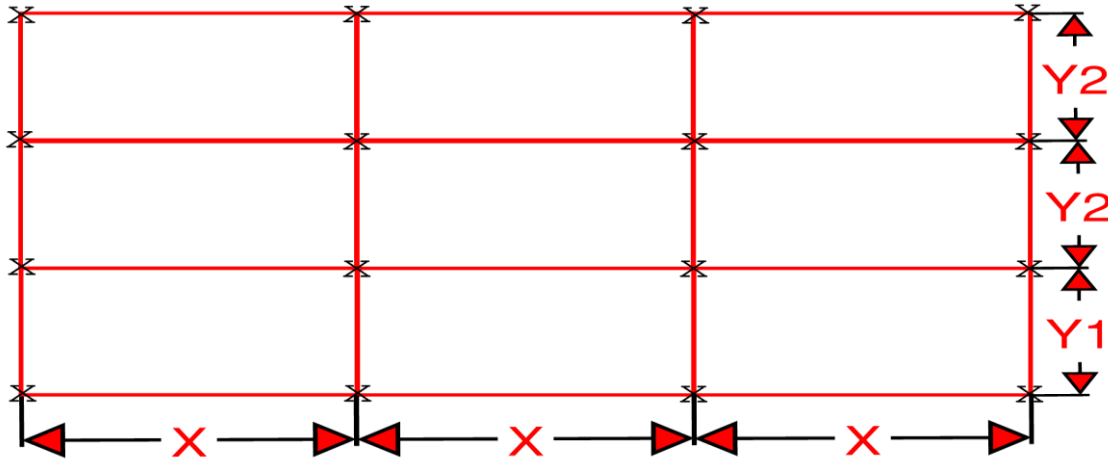

Laydown Straps

After proper attachment points are installed per approve plan set, simply layout SolarStraps on top of attachment points. Once straps are in place properly secure the attachment utilizing approved details on plan set.

NOTE:

ONCE THE CORRECT INTERLOCK SETTING HAS BEEN ESTABLISHED BY SOLARSTRAP AND/OR APPROVED PLANS BY AHJ/BUILDING DEPARTMENT. INTERLOCK ALL SSOP3 - SOLARSTRAP TO THE ESTABLISHED SETTING. THIS WILL MAKE THE INSTALLATION AND MOUNTING OF SOLARSTRAP COMPONENTS AND SOLAR EQUIPMENT FAST AND EASY.

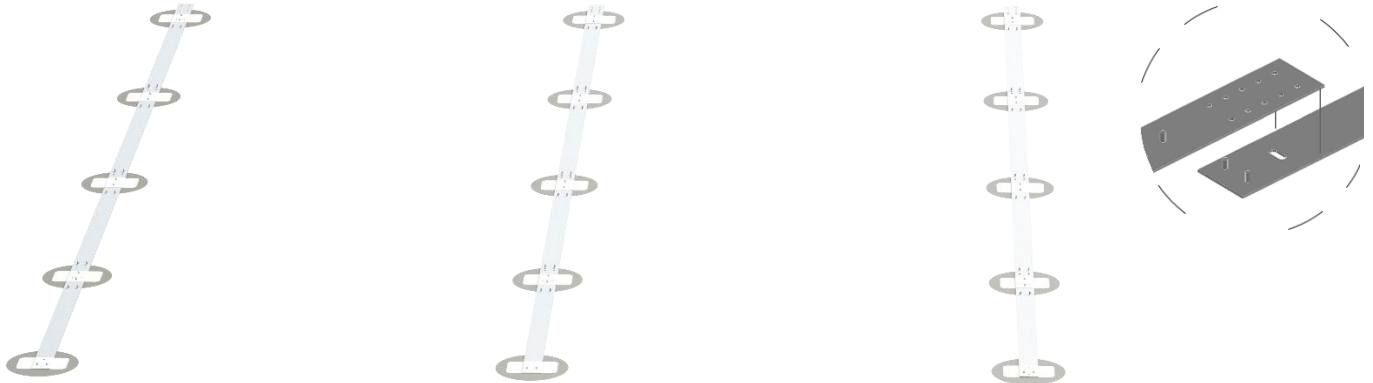

CAUTION

- Before performing any roof work a test fit must be accomplished by setting up a minimum of a 2 module by 2 module array and ensuring all attachments align with straps. Please call SolarStrap at 323-953-2969 and speak with technical support for help!

INSTALLATION

Add Brackets

After SolarStraps™ are laid down, simply place brackets over the integrated pem studs on the SolarStraps with top flanges facing inwards. The low bracket is for the sun-facing side and the high bracket for the shade-facing side. Fasten with Serrated Hex Flange Nuts to secure brackets, torque of **78 in.-lbs.**

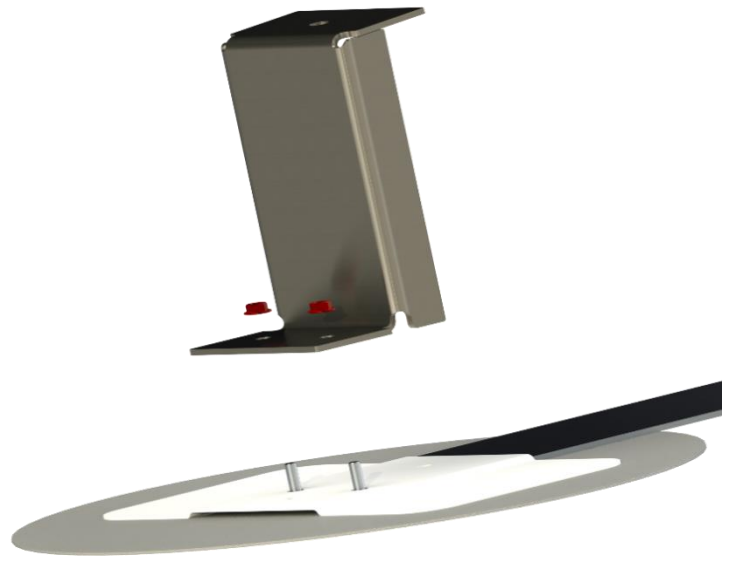

INSTALLATION

Place Modules

After brackets are secured, simply place modules on brackets. Install mid and end clamps and torque to 78 in.-lbs. or manufactures recommendation. Take special care to ensure modules are centered on brackets.

Note: For Sunpreme module torque to manufactures recommendations.

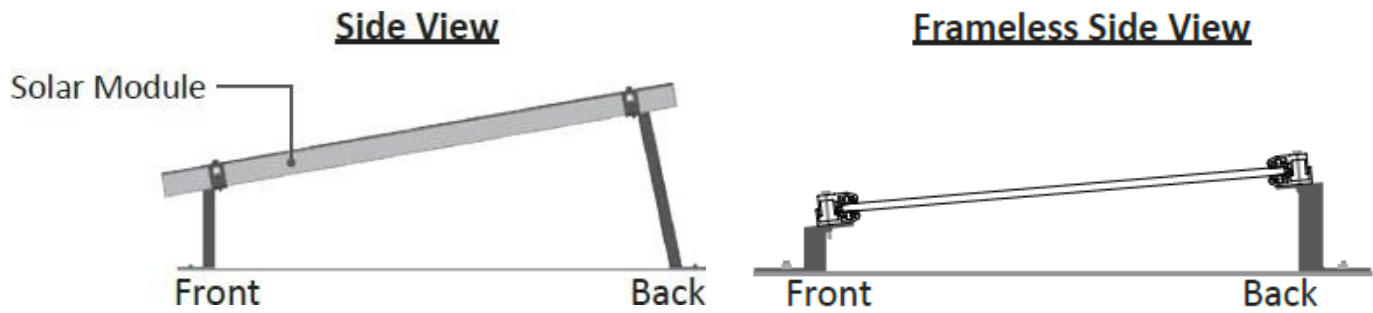

NOTE: Ensure the use of supplied split lock washer on mid clamp and end clamp bolts. (see pg. 11)
According to some AHJ clamps are considered single-use items, if you need to remove clamp it must be replaced with a new clamp. Please contact SolarStrap to acquire replacement hardware.

SolarStrap must be secured to the modules by using the supplied "Conductive Mid-Clamps and End-Clamps" (for framed modules) or the "Frameless End Clamps" for the frameless modules, such as Sunpreme.

CAUTION

Never leave unsecured modules on the roof unattended.

CLAMP INSTALLATION

Mid Clamp with Integrated Ground Installation

Install mid clamp utilizing supplies bolts and split lock washers. Take special care to ensure modules are centered on brackets.

Torque: Conductive Mid Clamp A3004 = 78 in. lbs.

Conductive Mid Cap 500100 = 78 in. lbs.

NOTE: Directions apply to all clamps sold by SolarStrap

1/4" Bolt
Split Lock Washer
Conductive Mid Clamp

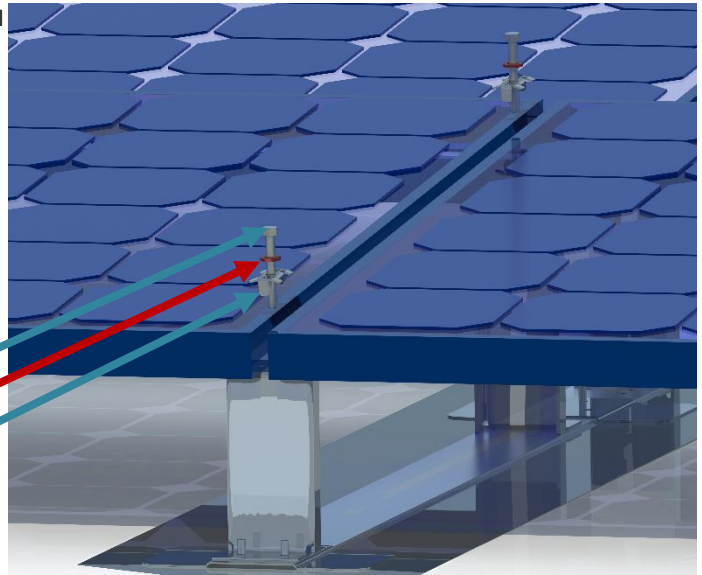

End Clamp with Integrated Ground Installation

Install End clamp utilizing supplies bolts and split lock washers. Take special care to ensure modules are centered on brackets.

Torque: Conductive End Clamp A3003 = 78 in. lbs

Conductive end Cap Universal 500101 = 78 in. lbs.

1/4" Bolt
Split Lock Washer
Conductive End Clamp

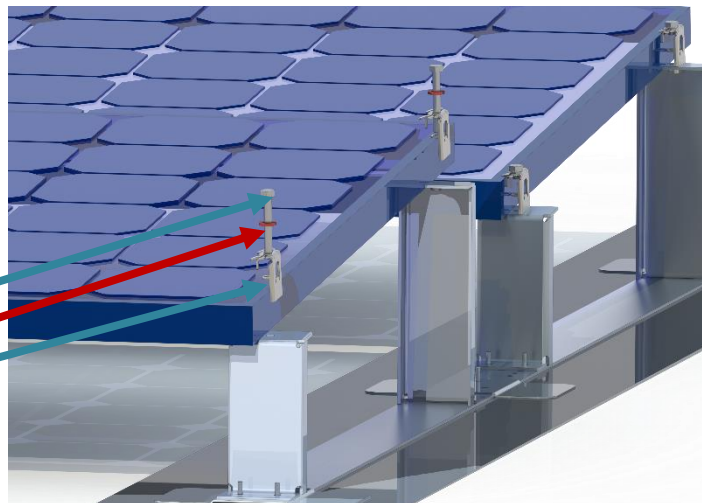

Note: For frameless modules, use Module Manufactures installation manual for torque spec.

Frameless Module setup

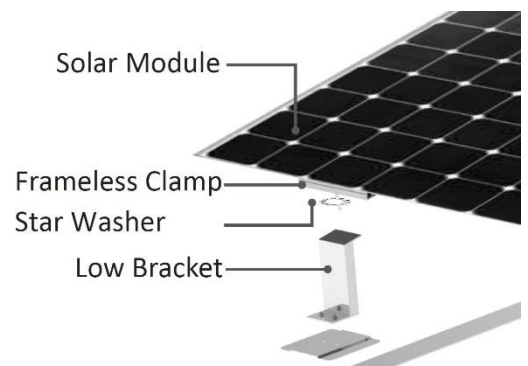

CAUTION

Over torquing could result in module damage and voiding of warranty. Never torque more than 78 in.-lbs. Clamps must be in proper location with the bolt center at the least 2.5" from the frame edge.

INSTALLATION

Wire Management and Grounding

The SolarStap™ is certified by UL2703 to be used for integrated grounding in two directions. (1) primary from module to module bonded by the Conductive Mid Clamp A3003 and (2) Through the SolarStrap connected to Mid Clamp A3004 or End Clamp A3003. For frameless modules the SolarStrap Bond Bar (SSBB) is used to connect SolarStraps together to maintain a continuous bond. The Maximum number of adjacent bonded PV modules or Straps from the “Grounding Lug” (SGB-4 or SGB-5) attached to the first supporting bracket is limited by the inverter DC ground conductor size or 360 modules, no more than 40 modules across from the SolarStrap connected to the grounding lug. For installations where some of the modules cannot be installed adjacent to each other the following methods may apply.

- A bare solid #6 AWG copper conductor or A #6 AWG stranded with XHHW-2 90°c insulation with a maximum length of 30 feet bonded using approved grounding lug (SGB-4 or SGB-5)
- Use of SSBB to bond gaps; including walkways
- The use of SSBB to bond frameless modules straps together is required since bonding not available through a module frame

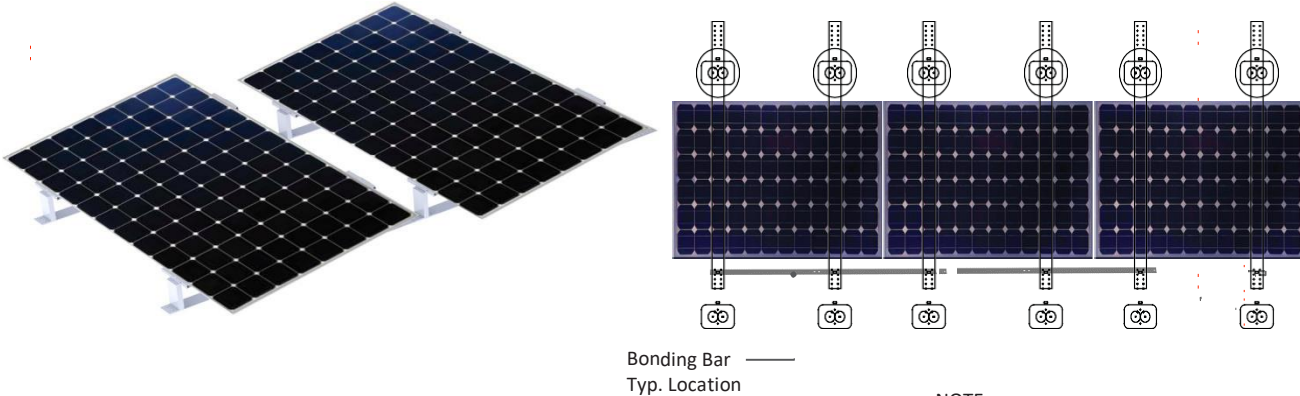

CAUTION

Employ best industry practices to ensure copper does not contact aluminum or galvanized steel.

Simply attach ground wire to the provided Grounding Lug (SGB-4 or SGB-5) fastened to the wing of the low or high bracket and connect the ground wire to the pull box that is mounted on the back of the high bracket. From the pull box run ground wire all the way to the inverter or combiner box per the electrical engineering drawing.

PVC Schedule 80, EMT, IMT, or Rigid conduit may be secured to any part of the brackets and should be six inches or more above the roof to minimize heat gain and wire heat losses. Conduit may pass under the array to take the most direct path to inverters or combiner boxes. For wire management use EMT or Schedule 80 PVC conduit supported by a one-hole strap and one self-tapping screw to attach your conduit to the side of the wing. Use plastic end protection if using EMT. EMT should be avoided for inter row crossings if the local AHJ requires bonding of EMT at these locations.

Note: A SSBB is only required on frameless modules, to bond the rows to columns. One per bonded 40 modules.
Note: This racking system may be used to ground and/or mount a PV module complying with UL 1703 only when the specific module has been evaluated for grounding and/or Mounting in compliance with the included instructions.

INSTALLATION

Grounding the Array Example

Up to 360 modules in an array requires one grounding lug (SGB-4 or SGB-5/Torque to 55 in. lbs) secured to one bracket. A bare #6 AWG solid copper or stranded wire with XHHW-2 90°C insulation may be used to bond each grounding lug (SGB-4 or SGB-5/Torques to 55 in. lbs) to the Earth Ground. The grounding lug must be placed on a continuous strap. Stranded rows of modules may ground through straps to the adjoining row. For islands of modules a bare #6 AWG solid copper or stranded wire with XHHW-2 90°C insulation jumper ground wire connects islands of modules together through grounding lugs (SGB-4 or SGB-5/Torque to 55 in. lbs) secured to one bracket per section. A SolarStrap™ Bond Bar (SSBB) can also be used to connect islands of modules. All bonding/grounding hardware is to be used in accordance with the National Electric code, ANSI/NFPA70

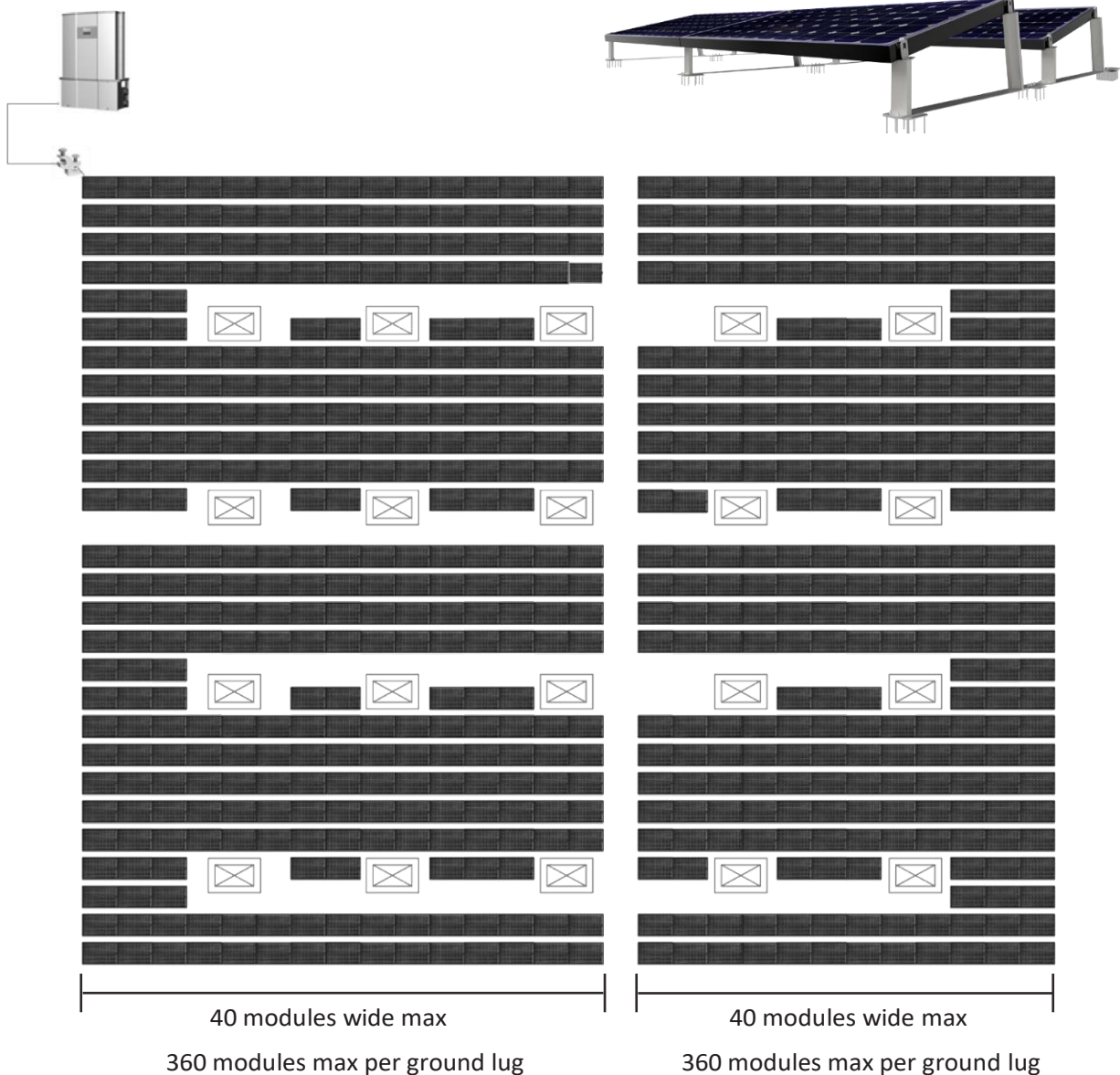

Application of Seismic Building Codes

SolarStrap™ is uniquely suited for installation of rooftop mounted PV solar systems in seismically active areas and on buildings with limited roof structural capacity. Due to its light weight and flexible mounting options, the SolarStrap™ is a viable option for a wide range of rooftops. Our design allows the SolarStrap™ to be mounted to the roof using one of three mounting options: structurally attached; ballasted; and a hybrid option that uses both ballasted and structural attachments. Calculations have been performed in accordance with the 2013 California Building Code (CBC), the governing building code in California, which references the 2012 International Building Code (IBC). The 2012 IBC references the 2010 Minimum Design Loads for Buildings and Other Structures, including Supplement No. 1, No. 2, and Errata, by the American Society of Civil Engineers (ASCE), referred to as ASCE 7-10. The anchorage designs have been designed to withstand code-prescribed seismic forces due to the self-weight of the racking system, the self-weight of the solar panels and the system's ballast, if present.

Our structural analysis and design of the SolarStrap™ and its method of attachment (ballasted, structurally attached and the hybrid ballasted with structural attachment) complies with Section 13.4 of ASCE 7-10, which states that all components shall be positively fastened to the structure without consideration of frictional resistance. The intent of our design is to provide a solution for various design parameters for seismic anchorage in a variety of site-specific conditions. Since there are many different possible seismic conditions, we can provide a site-specific seismic anchorage configuration with calculations to assure a safe installation and to obtain building permits. The seismic forces used in our calculations assume Site Class D and utilize short- period spectral accelerations as provided in ASCE 7-10. The design parameters may also be customized by roof material type.

Limitations

For certain projects, site-specific engineering may be recommended to help determine a very efficient custom installation cost. These various building-specific issues must be evaluated by the appropriate registered professional(s) prior to the addition of the photovoltaic and racking systems. A licensed structural engineer shall be consulted for building-specific structural evaluation.

ROOF CONNECTION

Basic Attachment Details for Built-up or Asphalt Roofs

NOTE: See approved plan set for site specific attachment details.

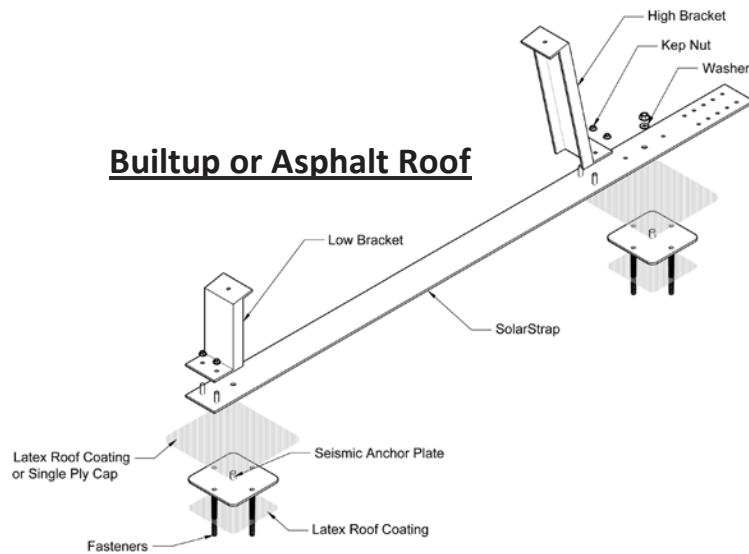

Note: EOR required to review suggested site plans. EOR shall review/recommend proper roof attachments that are commercially available

ROOF CONNECTION

Basic Attachment Details for TPO/PVC Roofs

NOTE: See approved plan set for site specific attachment details.

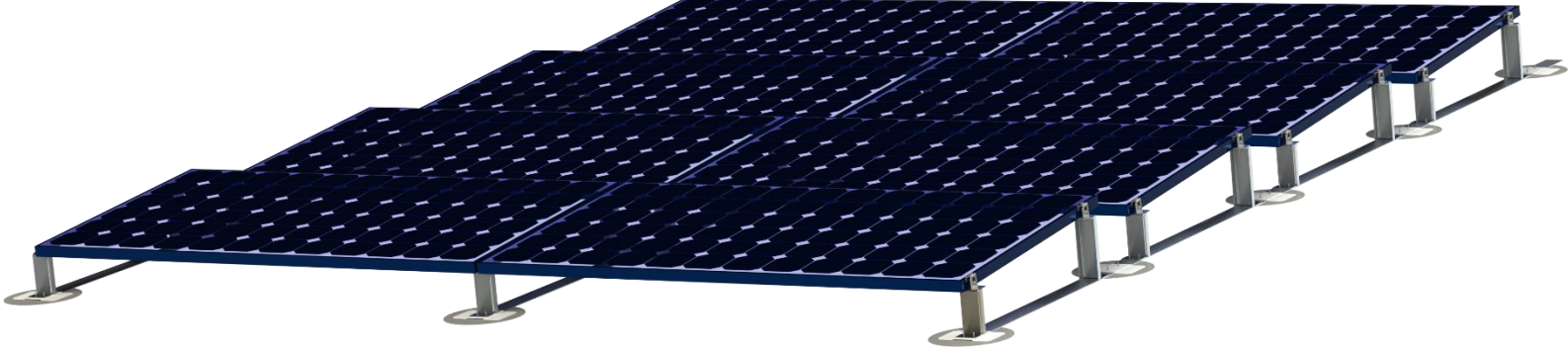

TPO or PVC Roofs

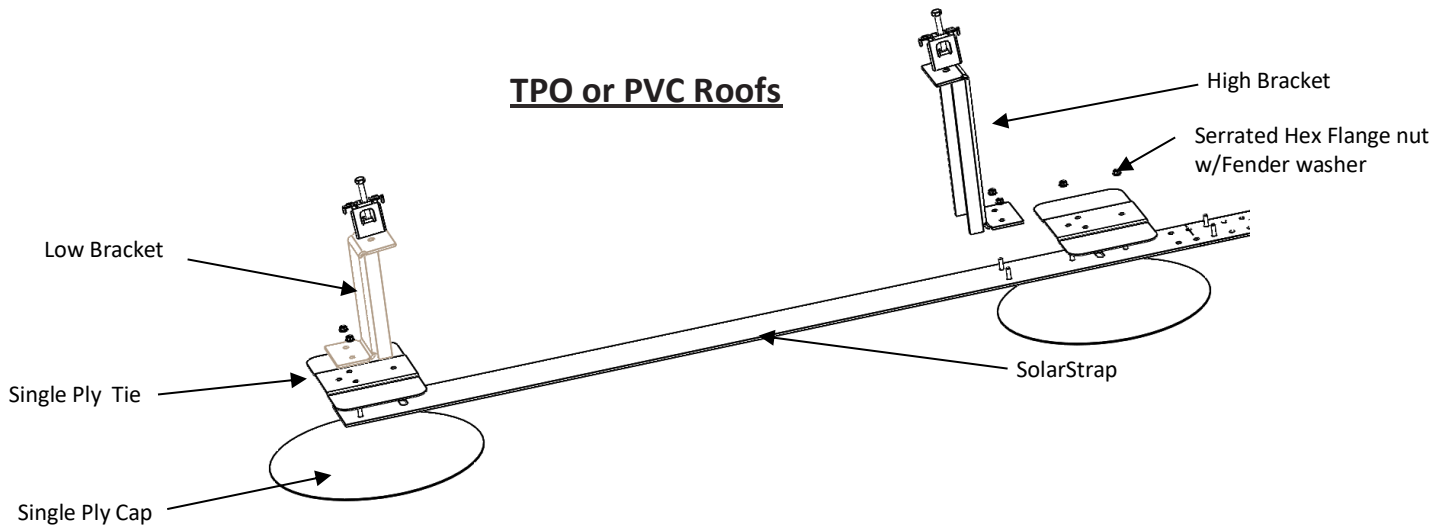

Note: EOR required to review suggested site plans. EOR shall review/recommend proper roof attachments that are commercially available

ROOF CONNECTION

Basic Attachment Details for Premium TPO/PVC Roofs

NOTE: See approved plan set for site specific attachment details.

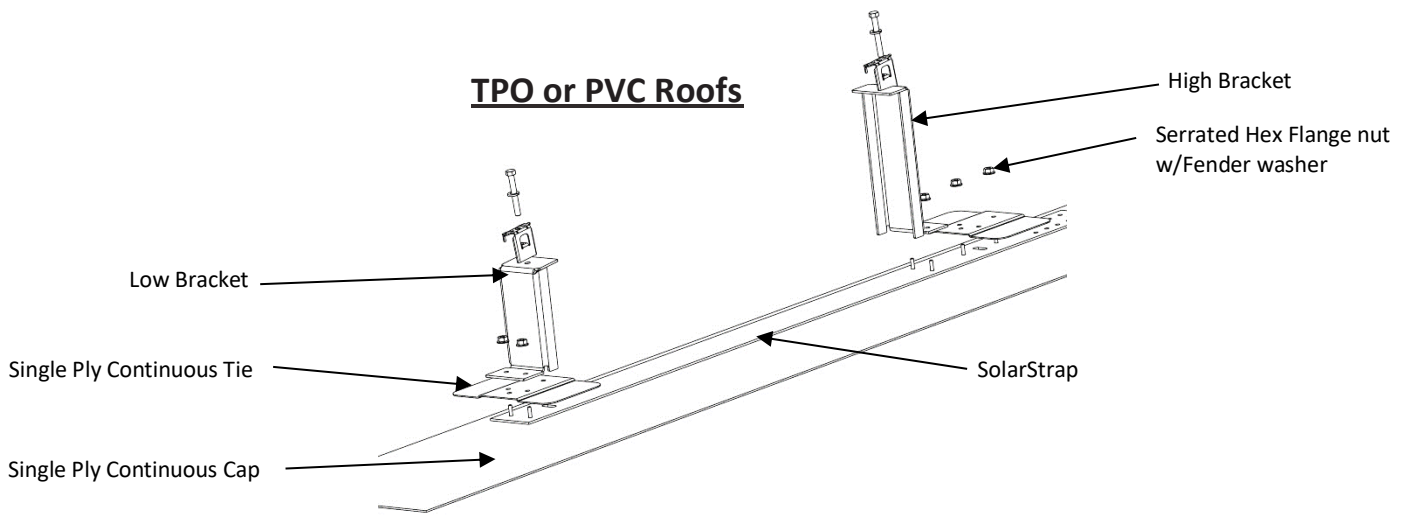

Note: EOR required to review suggested site plans. EOR shall review/recommend proper roof attachments that are commercially available

NOTES

Parts List

Product	Product Number	Quantity	Note
SolarStrap™ One Piece	SSOP3		
SolarStrap™ Bond Bar	SSBB		
SolarStrap™ Pan Strap	SSPS		
SolarStrap™ Inverter Mount Rack	SSIMR		
SolarStrap™ Attachment Plate	SSAP		
SolarStrap™ High Bracket 5°/10°/15°	SSHB		
SolarStrap™ Double High Bracket 5°/10°/15°	SSHBEW		
SolarStrap™ Low Bracket 5°/10°/15°	SSLB		
SolarStrap™ Double Low Bracket 5°/10°/15°	SSLBEW		
Conductive Mid Clamp	A3004		
Conductive End Clamp	A3003		
Conductive Mid Cap	500100		
Conductive End Cap Universal	500101		
Grounding Lug	SGB-4		
Serrated Hex Flange Nut	SSHWSFN		
Single Ply Continuous Cap	SSCC		
Single Ply Tie	SSPT		
Single Ply Cap	SSPC		

UL CERTIFICATIONS AND APPROVED MODULES

PTL UL2703 - Conformance

Fire Conformance

Solar PLT Reference File

- R1-PMC150609
- L2-PMC150609

Mechanical Conformance

Solar PTL Reference File

- L1-PMC151112
- L4-PMC150609

Electrical Conformance

Solar PTL Reference File

- L1-PMC161026
- L1-PMC170505
- L1-PMC170615
- L3-PMC150609

PTL UL2703 - Approved Modules

Boviet

- BVM6610P-XXX
- BVM6610M-XXX
- BVM6612M-XXX
- BVM6612P-XXX

Canadian Solar

- CS3U-XX-XXX
- CS3K-XX-XXX
- CS6U-XXXX
- CS6U-XXXM
- CS6U-XXXXP(1500V)
- CS6U-XXXM (1500V)

ecoSolargy

- ECOXXXH156P-72

Hansol

- HSXXTD-AN4

Hanwha Q Cells

- Q.PLUS L-G4.2 XXX
- Q.PEAK L-G4.2 XXX
- P.PLUS L-G4.1 XXX
- Q.PLUS L-G4 XXX
- Q.PRO L-G4 XXX
- Q.PRO L-G4.1 XXX
- Q.PRO L-G4.2 XXX
- B.LINE PLUS L-G4.2 XXX
- B.LINE PRO L-G4.1 XXX
- B.LINE PRO L-G4.2 XXX
- Q.PEAK DUO L-G8.3/BFG/BGT XXX
- Q.PEAK DUO XL-G9.3/BFG XXX

HT Solar

- HT72-156M(V)-C

Hyundai Heavy Industries

- MI-Series
- Hix-xxxHI

LG

- LG 280W
- LGXXXN2T-A5
- LGXXXN2W-A5
- LGXXXN1C-V5
- LGXXXN1K-A5
- LGXXX1C-A5
- LGXXXS2W-A5
- LGXXXS2W-G4
- LGXXXN2T-J5

Neo Solar Power Corporation

- D6MXXXE4A
- D6MXXXB4A
- D6MXXXE4AME

Panasonic

- VBHNXXXSA17
- VBHNXXXSA17G
- VBHNXXXSA17E
- VBHNXXXSA18E
- VBHNXXXSA18
- VBHNXXXSA15
- VBHNXXXSA16

Risen

- Rsm144-6-xxx

SunPower

- X-Series
- SPRxxxNE
- P Series
- SPR-PXX-XXX-COM

Solar World

- Sunmodule Pluse
- SW XXX Mono

Sunpreme

- Maxima GxB 360WB

Trina Solar

- TSM-PE14A
- TSM-DE15H(II)
- TSM-PD14
- TSM-DE14A(II) STD MONO
- TST-PE15H
- TSM-DE14A(II) PERC MONO

VSUN

- VSUN60X-XX
- VSUN72X-XX
- VSUN120X-XX
- VSUN144X-XX

ZNShine

- ZXM7-NH144-XXX/M182
- ZXM7-NHLDD144-XXX/M182
- ZXM6-NH144-XXX/M166
- ZXM6-NHLDD144-XXX/M166

NOTE: Consult site-specific installation drawings for system load ratings

SolarStrap™ Limited Warranty Statement

Product	Product Number	Duration of Limited Warranty
SolarStrap™ One Piece/Gen3	SSOP3/Gen3	25 Years
SolarStrap™ Attachment Plate	SSAP	25 Years
SolarStrap™ Pan Strap	SSPS	25 Years
SolarStrap™ Double High Bracket (5°, 10°, 15°)	SSHBEW	25 Years
SolarStrap™ Low Bracket (5°, 10°, 15°)	SSLB	25 Years
SolarStrap™ Double Low Bracket (5°, 10°, 15°)	SSLBEW	25 Years
Conductive Mid Clamp	A3004	25 Years
Conductive End Clamp	A3003	25 Years
Conductive End Cap Universal	500101	25 Years
Conductive Mid Cap	500100	25 Years

A. Extent of Limited Warranty

1. SolarStrap warrants to the end-user customer that the SolarStrap products specified above will be free from defects in materials and workmanship for the duration specified above, which duration begins on the date of purchase by the customer.
2. SolarStrap's limited warranty covers only those defects that arise as a result of normal use of the product, and does not cover any other problems, including those that arise as a result of:
 - a. Improper maintenance or modification;
 - b. Parts or supplies not provided or supported by SolarStrap;
 - c. Operation outside the design specifications or engineering;
 - d. Unauthorized modification or misuse.
3. If SolarStrap receives, during the applicable warranty period, notice of a defect in any product which is covered by SolarStrap's warranty, SolarStrap shall either repair or replace the product, at SolarStrap's option.
4. If SolarStrap is unable to repair or replace, as applicable, a defective product which is covered by SolarStrap's warranty, SolarStrap shall, within a reasonable time after being notified of the defect, refund the purchase price for the product.
5. SolarStrap shall have no obligation to repair, replace, or refund until the customer returns the defective product to SolarStrap.
6. Any replacement product may be either new or like-new, provided that it has functionality at least equal to that of the product being replaced.
7. SolarStrap products may contain remanufactured parts, components, or materials equivalent to new in performance.
8. SolarStrap's Limited Warranty Statement is valid in any country where the covered SolarStrap product is distributed by SolarStrap. Contracts for additional warranty services, such as on-site service, may be available from any authorized SolarStrap service company in countries where the product is distributed by SolarStrap or by an authorized importer.

B. Limitations of Warranty

To the extent allowed by local law, neither SolarStrap nor its third-party suppliers makes any other warranty or condition of any kind, whether express or implied warranties or conditions of merchantability, satisfactory quality, and fitness for a particular purpose.

C. Limitations of Liability

1. To the extent allowed by local law, the remedies provided in this Warranty Statement are the customer's sole and exclusive remedies.
2. To the extent allowed by local law, except for the obligations specifically set forth in this warranty statement, in no event shall SolarStrap or its third party suppliers be liable for direct, indirect, special, incidental, or consequential damages, whether based on contract, tort, or any other legal theory and whether advised of the possibility of such damages.
- D. Projects located within 2.5 miles of the ocean must use marine grade option, using either coated stainless steel serrated hex flange nut, pem studs, and pem nuts or these items made in aluminum.

The only warranties for SolarStrap products and services are set forth in the express warranty statements accompanying such products and services. Nothing herein should be construed as constituting an additional warranty. SolarStrap shall not be liable for technical or editorial errors or omissions contained herein. In order to keep full warranty, please design and build per installation manual guidelines.

SolarStrap™ Installation Manual Copyright© 2021 by SolarStrap. All rights reserved www.solarstrap.com

Warranty check list

Log of changes to install manual

Revision Number	Date	Description of Change
SSIM REV 070717	07/07/2017	First Draft
SSIM REV 091917	09/19/2017	Submittal to TUV for Certification
SSIM REV 012018	01/20/2018	Updated per TUV review comments
SSIM REV 012318	01/23/2018	Updated per TUV review comments
SSIM REV 012418	01/24/2018	Updated per TUV review comments
SSIM REV 013018	01/30/2018	Minor Format changes/Added Hansol HSXXTD to approved list
SSIM REV 030118	03/01/2018	Clarify SSTFEC installation.
SSIM REV 011520	01/15/20	Updated to SolarPTL Certs, Added Modules to list, Clarified Installation directions, Updated warranty to 25 years.
SSIM REV 091920	09/19/20	Added FUI 2020 requirement, revert to SSPC from SSCC, Updated approved module list
SSIM REV 012921	02/15/2021	Added new mid and end clamps, Approved modules PTL updates.
SSIM REV 082622	08/26/2022	Updated approved module list, updated layout measurements
SSIM REV 100223	10/02/2023	Removed GEN3, SSSP, Connecting strap for ETL preliminary transfer
SSIM REV 111323	11/13/2023	Added pan strap back into manual

Warranty check list

Warranty check list

Part	Required	Actual
¼-20 Module Clamp bolt torque	78 in-lb Torque	
¼-20 Hex Flange Nuts for brackets	78 in-lb Torque	
Tie Heat Welds if required	2in each side	
Cap Heat Welds if required	Fully welded	
¼-20 Hex Flange nuts for ties	Snug	
5/16-18 Hex Flange Nuts if required	78 in-lb Torque	
SolarPTL Stamp on straps	Each strap	

Project name

Project address

Inspectors printed name

Signature

Date

Check list shall be completed by site foreman representing solar install team.
